

ICS Switch Panel

The ICS Switch Panel has been developed specifically to control lighting and other electronic automotive accessories and incorporates the latest in onboard circuit protection technology.

The switch panel and receiver communicate using a proprietary signal which allows the switching system to be configured using a single receiver module for typical applications, or with additional slave receiver modules on larger systems or vehicles.



Projected Capacitive Touch

Projected capacitive touch (PCT also PCAP) technology is a variant of capacitive touch technology but utilises a simple form of "Artificial Intelligence" to improve sensitivity to touch, accuracy, resolution and speed of touch.

This intelligent processing enables finger sensing to be projected, accurately and reliably, through very thick glass and even double glazing.

Unlike traditional capacitive touch technology, it is possible for a PCT system to sense a passive stylus or gloved finger.

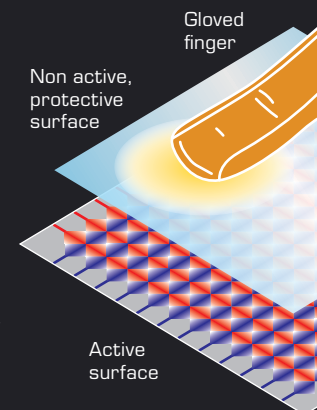

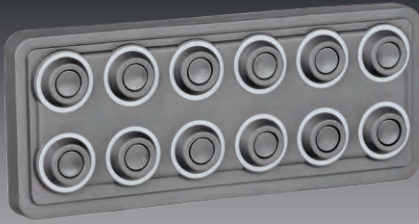

Displays / HMI

Ultraview Touch Series	14
Ultraview Monochrome	20
Smart Touch Switch Panels	24
ICS Switch Panel Kit	26
Intelli-Tank Level 40	28
Engine Information Centre	31
Seat Belt Warning System	34
Minder Series Kits	36

Multiplexing

Multiplexing

Multiplexing is a digital communication system using a controller area network (CAN) to link modules together in a backbone network topology.

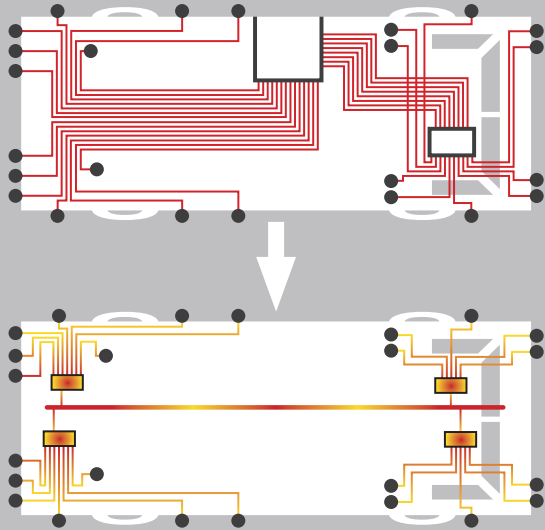

Commonly used in vehicle based and mobile plant applications, multiplexing removes the requirement for large bulky relay and fuse panels and drastically reduces the number of wires required for electrical installations.

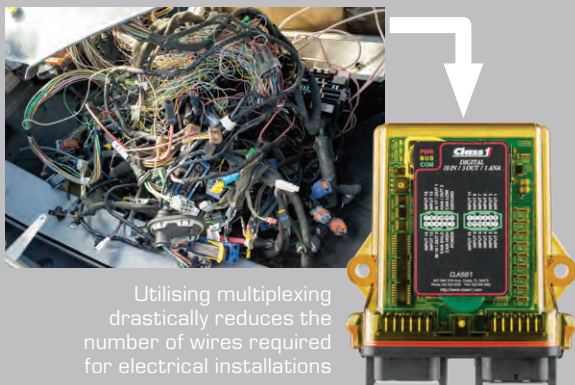

Utilising multiplexing drastically reduces the number of wires required for electrical installations

In every installation reliability is paramount and occasionally where things don't go smoothly technicians need to be able to rectify any issues quickly and easily. In traditionally wired electrical systems finding broken wires, short circuits or faulty components can be time consuming and costly, not to mention every connection is a potential failure point.

In multiplexed systems each device around a vehicle is connected to a module using a single wire, without the requirement for fuses and relays to switch the current and protect the harness. This results in less wiring per device than in a traditionally wired electrical system.



Additionally, each module is interconnected to each other by the CAN backbone, meaning any complex logic required of the system is seamlessly handled through programming rather than intricate wiring techniques.



Utilising software with input/output data, the system is then able to provide useful diagnostic information to both the operator and the technician for use in finding any fault.



The Class 1 multiplexing system has been designed, tried and tested in the harshest of conditions on some of the most complex machines. Meaning Class 1 is ready take on any application offering faster build times, greater reliability and more flexibility through reduced connections. Additional information at the user's fingertips and advanced diagnostic data for technical and service staff, makes for an extremely powerful mobile electrical control system.

Diagnostic Capabilities

By far one of the most powerful features of this multiplexed electrical system is the enhanced diagnostic function available to the technician.

Multiple reports are available which can help track all actions and associations in the system.



The technician is able to enter the system, via a PC or the Information Display if installed, to quickly diagnose the exact problem, often without even picking up a tool.

Communication Method

Messages are sent from node to node over the J1939 CAN (Controller Area Network) data bus and are simple 8-bit signals, similar to the signals used in your computer at home.



The signals transfer throughout the system at a rate of 250,000 bits per second, allowing plenty of room for all messages to get to and from the respective nodes.

Additionally, using the communication network, the system can constantly monitor any device attached to it.

Through the intelligence of the software, the multiplexed system can be "taught" to look for certain problems and conditions in the system and act on the information, or indicate the condition to the operator on the System Display. This communication tool will increase the operator's ability to monitor and control activity on the vehicle.

Multiplexing

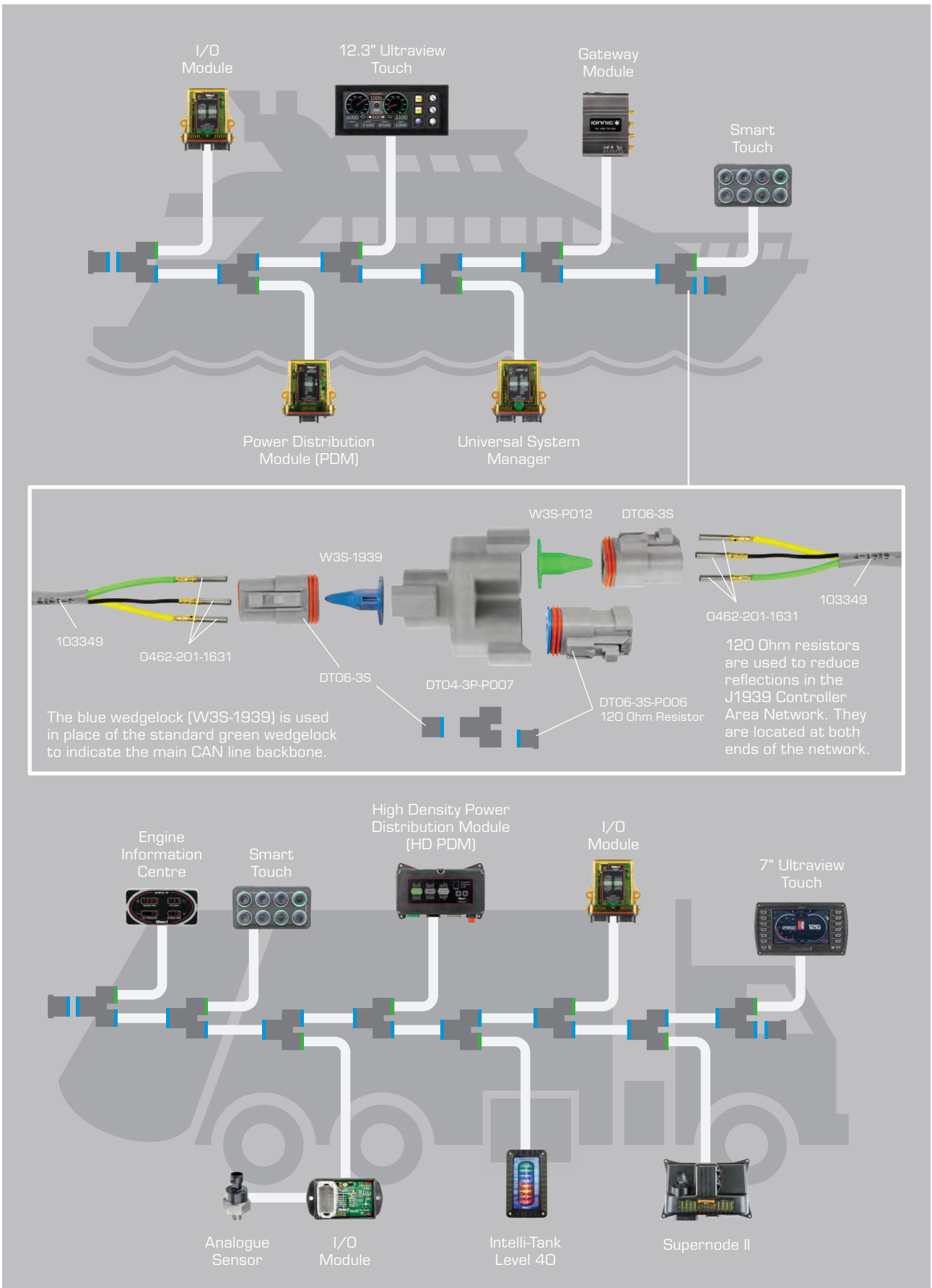

Ultraview Touch Series



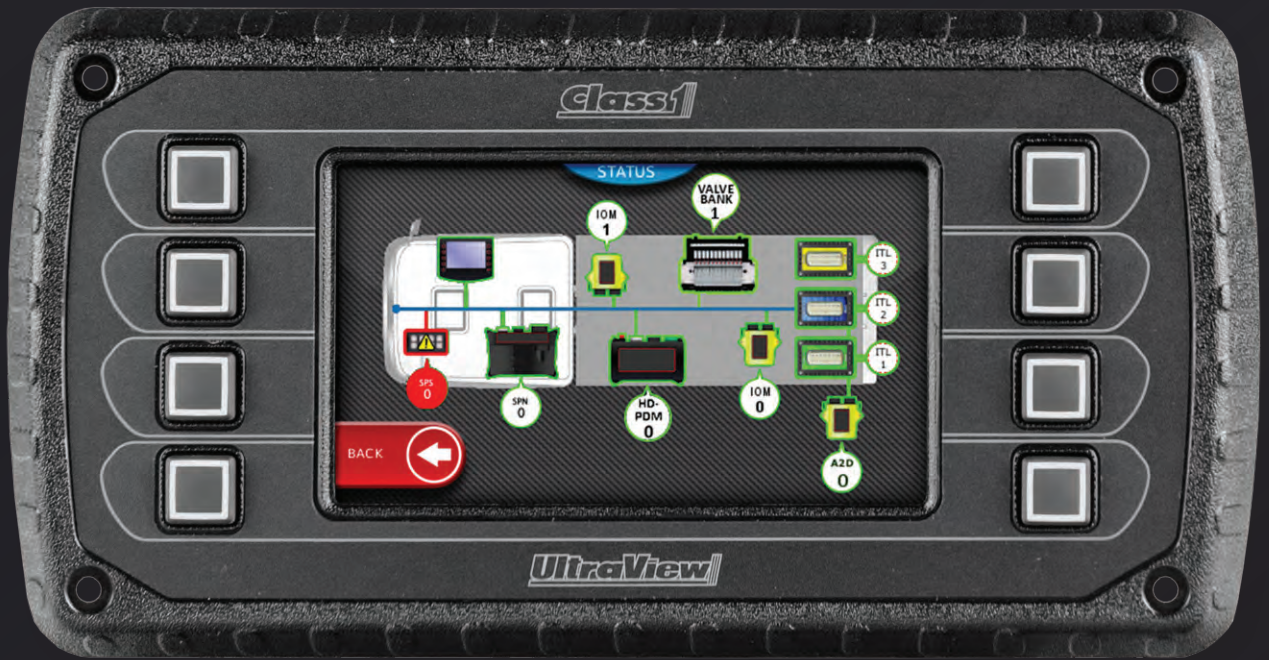

CLASS1
ELECTRONICS

Displays / HMI

Ultraview Touch Series



6V 36V IP67 Made in North America

- Projected capacitive touch screen on all models – can be used while wearing gloves.
- J1939 CAN based information display incorporating programmable switching.
- Infinitely customisable.
- Bonded LCD screen viewable in direct sunlight and whilst wearing polarised lenses.
- Reverse polarity and EMF protected.
- Horizontal or vertical screen orientation.
- Environmentally sealed – IP67.
- Models with tactile buttons.
- Multi-voltage.
- Made in North America.

Voltage : 6–36V
Video Input : NTSC/PAL
Output : Digital 500mA
CAN : SAE J1939, NMEA 2000
Construction : Polycarbonate
Ingress Protection : IP67
Vibration : 7.86G rms 5–2000 Hz, 3 axis
Shock : +/- 50G, 3 axis
Operating Temperature : -40°C to 85°C

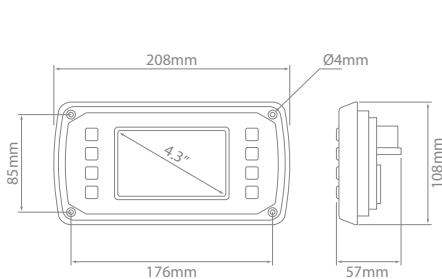

2045-052-00-CL1
"UV450"

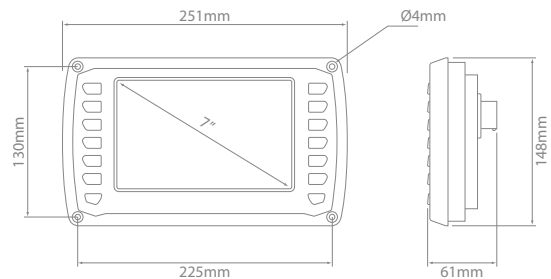

2070-053-00-CL1
"UV700"

Ultraview Touch Series – Tactile

Part No.	Description	Screen Size	Resolution	Configurable Inputs	Video Inputs	Outputs	Current Draw (mA)	
							@ 14.4V	@ 28.8V
2045-052-00-CL1	UV450	4.3"	480 x 272	1	2	1	100	100
2070-053-00-CL1	UV700	7"	800 x 480	3	3	1	600	300

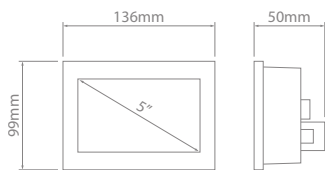

610-00060-050
"UV500"

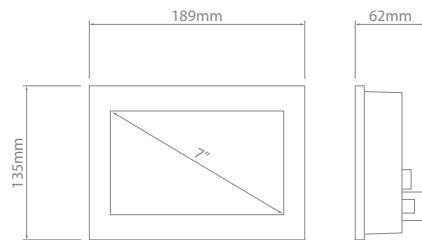

610-00060-080
"UV800"

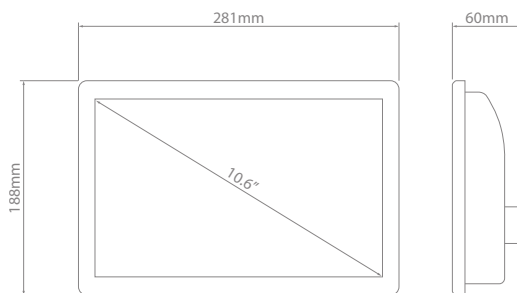

610-00060-110
"UV1100"

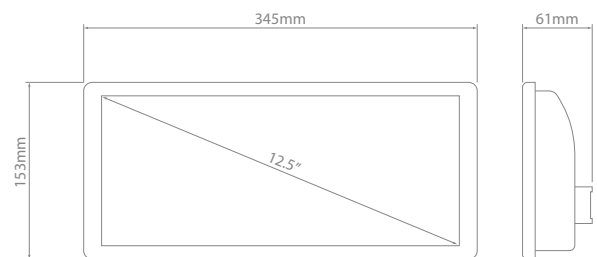

610-00060-120
"UV1200"

Ultraview Touch Series



Part No.	Description	Screen Size	Resolution	Configurable Inputs	Video Inputs	Outputs	Current Draw (mA)	
							@ 14.4V	@ 28.8V
610-00060-050	UV500	5"	800 x 480	1	2	1	400	300
610-00060-080	UV800	7"	800 x 480	8	3	2	900	600
610-00060-110	UV1100	10.6"	1280 x 480	8	3	2	1200	700
610-00060-120	UV1200	12.3"	1280 x 768	8	3	2	1300	800

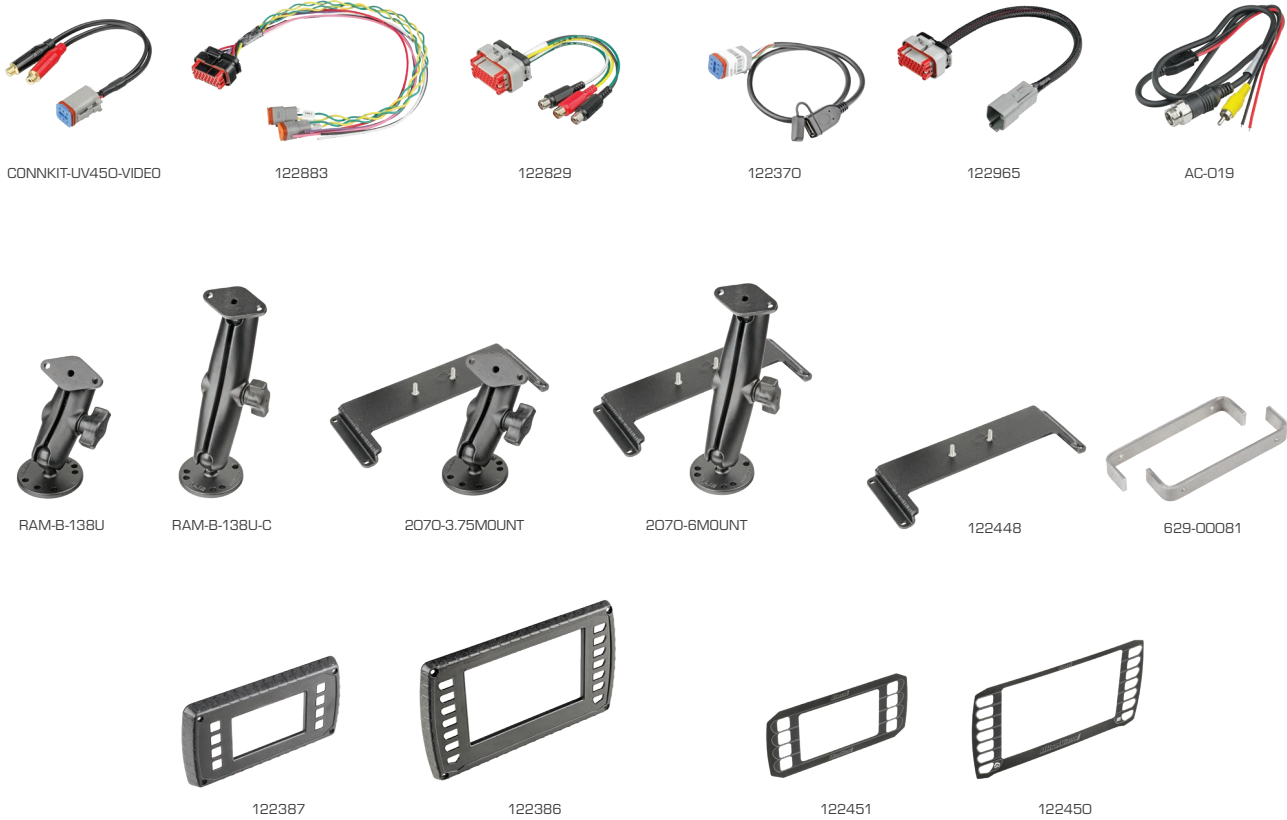

Displays / HMI





Ultraview Touch Series – Accessories – UV450, UV500 & UV700

Part No.	Description	 UV450	 UV500	 UV700
CONNKIT-UV450-VIDEO	Pre-terminated connector – CCTV	•	—	—
122883	Pre-terminated connector – CAN & Power	—	—	•
122829	Pre-terminated connector – 3x RCA	—	—	•
122370	Programming cable	•	—	•
122965	Programming cable *	—	—	•
AC-019	Adaptor – Connect Backeye Elite cable to RCA connector	•	—	•
RAM-B-138U	Mounting bracket – Adjustable pedestal – 80mm	•	•	—
RAM-B-138U-C	Mounting bracket – Adjustable pedestal – 150mm	•	•	—
2070-3.75MOUNT	Mounting bracket kit – Adjustable pedestal – 80mm	—	—	•
2070-6MOUNT	Mounting bracket kit – Adjustable pedestal – 150mm	—	—	•
122448	Mounting bracket	—	—	•
629-00081	Mounting bracket – Panel mount	—	•	—
122387	Bezel	•	—	—
122386	Bezel	—	—	•
122451	Decal	•	—	—
122450	Decal	—	—	•

* UV700 requires both 122370 and 122965 cables for programming.









Ultraview Touch Series – Accessories – UV800, UV1100 & UV1200

Part No.	Description			
		UV800	UV1100	UV1200
122883	Pre-terminated connector – CAN & Power	•	•	•
122829	Pre-terminated connector – 3x RCA	—	•	•
513-00144-001	Pre-terminated connector – 1x RCA	•	—	—
513-00144-005	Pre-terminated connector – 5x RCA	•	—	—
RAM-B-138U	Mounting bracket – Adjustable pedestal – 80mm	•	—	—
RAM-B-138U-C	Mounting bracket – Adjustable pedestal – 150mm	•	—	—
629-00071	Mounting bracket – Panel mount	—	•	—
610-00061-080	Bezel with tactile buttons	•	—	—
M12-CAP	Screw on cap for M12 male connector. 130mm length	•	•	•



Ultraview Touch Series – Connection Kits

Part No.						
	UV450	UV500	UV700	UV800	UV1100	UV1200
CONNKIT-UV450	•	•	—	—	—	—
CONNKIT-UV700	—	—	•	—	—	•
CONNKIT-UV800	—	—	—	•	—	—
CONNKIT-UV1100	—	—	—	—	•	—

Crimping tools can be found on page 96.
Supplied with bolts/nuts and washers.



Displays / HMI

Configuring the Ultraview Displays



Smart Touch Panel, found on page 24.

Personalisation



Splash/Intro

An initial screen shown during the power up of the Ultraview display can be customised with manufacturer/customer logo, graphic or message.

Display Video



Video

Ultraview screens can display video from either PAL or NTSC cameras. The image can be configured to the full height of the display or resized to be viewed in conjunction with other on-screen elements.

The Ultraview Touch interface can be infinitely customised to display and interact with the user, either through physical buttons, via touch screen or both.

If a design can be imagined, then the Class 1 team can assist in turning your concept into reality.

Once all operational requirements are determined, an interface is designed and programmed specifically for the application. All graphical elements including, colours, backgrounds, dials, gauges etc can be enhanced with real time animation.

A range of standard templates are available for less complex interface requirements.

Touch Interface

Touch Screen

Directly touching an icon or image on a screen is a popular and intuitive way to interact with a device.

Not being restricted by physical switches allows for a greater variety of actions and increased operational efficiency.

Combination

Some operators prefer physical buttons, others instinctively touch the screen.

The Ultraview series allows for both to be used, providing system designers and operators the flexibility to perform tasks in a manner best suiting their preference.



Tactile Push Buttons

Backlit push buttons are able to be configured to operate with all Ultraview displays. The switches are designed to provide positive tactile confirmation when pressed, even when wearing gloves, giving the operator confidence when actuating a switch function.

Warnings

There are several methods available to draw an operator's attention to a specific area of the Ultraview interface. The most popular are shown below.

Banner

This is typically a partial overlay on the current working screen when a trigger is activated or a parameter is out of range. This could show momentarily, or clear upon confirmation or item rectification.

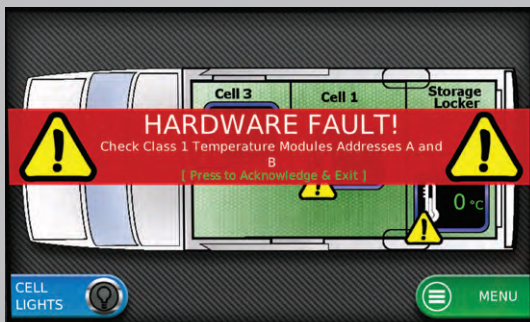

Highlights

A gauge face turning red, a section of a graphic changing colour or simulated illumination can be used to show that a particular function is activated, a door or locker open or a work lamp is turned on.



Icons

Used in a similar way to a warning lamp or status notification, icons can be used to show that an item is activated or that a component is out of its operating range.

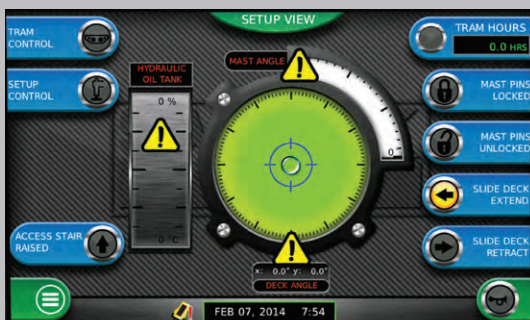

Combination

A combination of these events may be used to illicit action by the operator. The Ultraview Series also provides an output for an audible alarm if required.

Gauges

Traditionally machine operations are represented through analogue instruments and devices, the most effective of these have been programmed to display virtually on screen in the Ultraview series.

Rotary

The most common gauges viewed in equipment today. Typically a round fascia with a coloured needle to indicate the level reached by the sensor/pickup. The flexibility of the Ultraview rotary gauge is the ability to design it to whatever size, shape, colour etc the user desires.

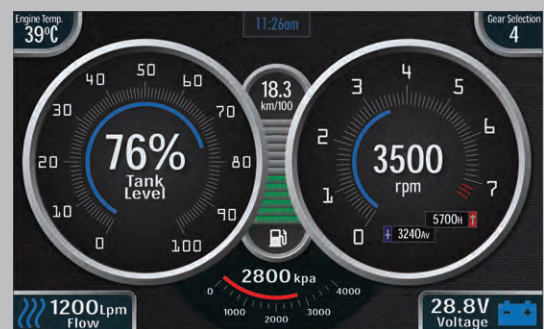

Bar

A column of colour moving on a scale to indicate the feedback from a sensor or pickup. Orientation, colour, and triggered effects can be applied to this gauge to bring this component to life. Curving a bar graph around a gauge or graphic can add to the visual effect whilst being more space efficient.



Text/Digital

Usually a numerical value that changes based on the feedback from the sensor or pickup. Size, colour, and update rate are configurable to suit operational needs.



Combination

Combining two or more gauges is often the best way to display multiple pieces of related information at a glance. The flexibility of the Ultraview configuration software enables this and many more creative ideas.





- Easy to read QVGA 3.8" monochrome LCD screen with backlight and heater.
- Displays gauges, soft key commands, and custom messages.
- 5 tactile push buttons.
- J1939 CAN based information display incorporating programmable switching.
- Custom interfaces available on request.
- Reverse polarity and EMF protected.
- Connector kits available providing all required connectors, contacts etc.
- Environmentally sealed – IP67.
- Multi-voltage.
- Made in North America.

6V 36V IP67 Made in North America

Voltage : 6-36V
Current Draw : 130mA @ 13.8V
Resolution : 320 x 240
Output : Digital 500mA
CAN : SAE J1939
Construction : Polycarbonate/ABS
Ingress Protection : IP67
Vibration : 7.86G rms 5.2000 Hz, 3 axis
Shock : +/- 50G, 3 axis
Operating Temperature : -40°C to 85°C

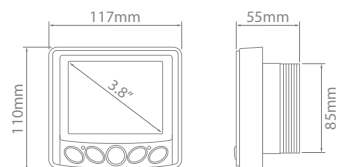

Ultraview Monochrome

Part No.	Description	Screen Size	Inputs	Outputs
610-00026	UV26	3.8"	1 x Resistive Analogue	1 x 500mA
610-00027	UV27	3.8"	4 x Resistive Analogue, 1 x Analogue, 1 x Frequency	1 x 500mA, 1 x 5V Supply 70mA



CONNKIT-UV26

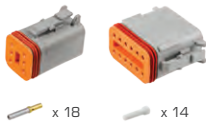

CONNKIT-UV27



M12-CAP

Ultraview Monochrome – Accessories

Part No.	Description	Suits
CONNKIT-UV26	Connection kit with M12 harness – 2m	UV26 (610-00026)
CONNKIT-UV27	Connection kit	UV27 (610-00027)
M12-CAP	Screw on cap for M12 male connector. 130mm length	UV26 (610-00026)

Crimping tools can be found on page 96.

Custom Interfaces

The Ultraview Monochrome units can have custom interfaces designed for specific application requirements.

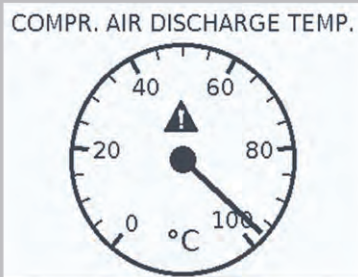

J1939 Engine Speed	2400 RPM
J1939 Oil Pressure	62 kPa
J1939 Oil Temp	112 °C
J1939 Coolant Temp	85 °C
J1939 Alt. Potential	14.1 V
J1939 Battery Potential	12.6 V
J1939 Alt. Current	135 A
J1939 Battery Current	0.1 A
J1939 Engine Torque	99 %
J1939 Ambient Air Temp.	28 °C
J1939 Cabin Air Temp.	26 °C

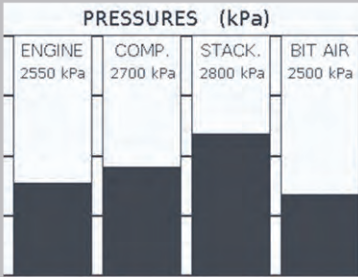

Mining Equipment



UV700



Supernode II



UV1100



HD PDM



Smart Touch



Climate Control
Module



PDM



I/O Module





ent Drilling Rigs

The mining industry demands reliability and serviceability to ensure equipment operates to capacity in harsh conditions.

Operator safety is paramount, and Class 1's ability to easily create complex safety interlocking makes this task possible.

Using next generation technology, Class 1 are at the forefront of industry performance in difficult environments.

- Fluid, pressure, temperature level indication
- Fluid flow control
- Lighting control
- Switch operation
- Safety interlocking
- Critical system monitoring
- Subsystem control and monitoring
- Interface with OEM engines
- Inbuilt diagnostics
- Machine angle monitoring
- Air conditioning climate control
- Multi-level password access



610-00061-004

610-00061-008

9V 32V IP68 Made in North America

- Dimmable illumination.
- LED backlit icons.
- Selectable coloured LED rings.
- Switch inserts can be laser etched.
- Vertical/horizontal mount.
- Low current draw.
- TE DEUTSCH compatible connector.
- Environmentally sealed – IP68.
- Made in North America.

Operational Voltage : 9-32V
 Max. Current Draw : 65mA @ 13.8V
 CAN : SAE J1939
 Construction : Silicone
 Ingress Protection : IP68
 Operating Temperature : -40°C to 85°C

Laser Etched Inserts Available

For further information ask your local reseller or enquire online at ionnic.com



CONNKIT-SMARTTOUCH



101-00296-016



101-00296-017



101-00296-018

Smart Touch Switch Panels – Accessories

Part No.	Description
CONNKIT-SMARTTOUCH	Connection Kit
101-00296-016	Switch Insert – Black
101-00296-017	Switch Insert – Red
101-00296-018	Switch Insert – Green

Switch inserts sold individually.

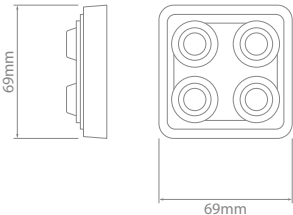

610-00061-004

Illuminated



TE DEUTSCH compatible connector on all panels

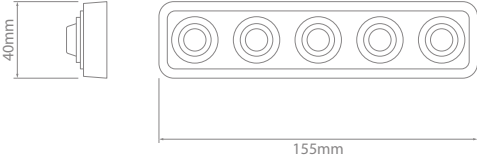

610-00061-005

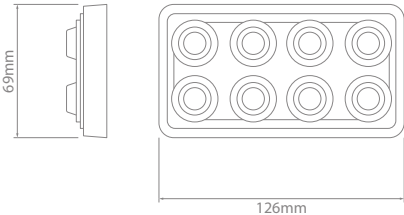

610-00061-008

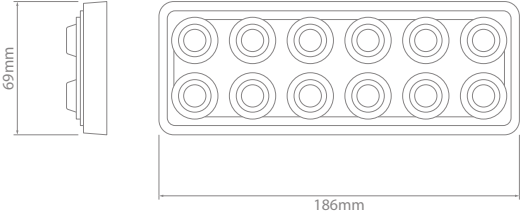

610-00061-012

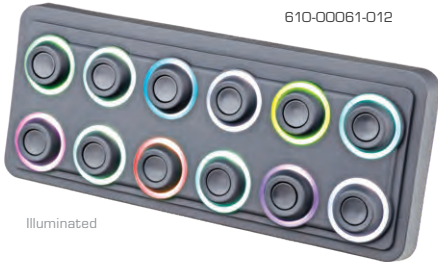

Illuminated

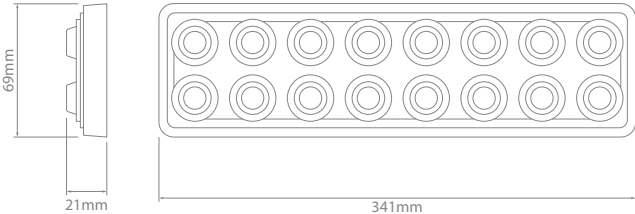

610-00061-016



Smart Touch Switch Panels ★ Featured

	4 Switches	5 Switches	8 Switches	12 Switches	16 Switches
Part No.	610-00061-004	610-00061-005	610-00061-008	610-00061-012	610-00061-016

All switch panels supplied with inserts to suit.





Actual size

12V
24V

- Developed to control lighting and other electronic automotive accessories.
- Incorporates the latest in onboard circuit protection and monitoring technology.
- Each output surge protected to 6A.
- 3 user configurable master switches.
- All switches can be set to latching or momentary.
- Mounting point on back of switch panel – use with common 1/4" thread adjustable mounts.
- Epoxy encapsulated receiver module for enhanced moisture and vibration protection.
- Includes 4 decals.
- 8 outputs (6A each).
- Multiple outputs can be combined to allow switching of high current loads.
- Eliminates excess wiring.
- Multi-voltage.
- Compact design.

Voltage :	12–24V
Outputs :	8
Max. Output Current Rating (per output) :	6A
Max. Output Current Rating (total) :	40A
Cable Length :	4.5m
Construction :	ABS
Operating Temperature :	-40°C to 85°C

The ICS Switch Panel has been developed to control all types of lighting and other electronic automotive accessories.

The switch panel and receiver communicate using a proprietary signal which allows the switching system to be configured using a single receiver module for typical applications, or with additional slave receiver modules on larger systems or vehicles.

The ICS Switch Panel incorporates the latest in onboard circuit protection technology. In the event of a short circuit the system immediately turns off the affected output preventing damage to the switch panel and devices controlled by it.



The panel provides real time feedback to the operator via LED's on both the panel and receiver module as to the state of each output.

In the event of an intermittent short circuit the output of the affected circuit will turn off and remain off for 4 seconds.

After this period of time the ICS will check the circuit, if no short is present it will automatically turn the output back on.

All circuits are monitored and controlled independently. In the case of a short circuit only the affected output is isolated while all others remain operational.

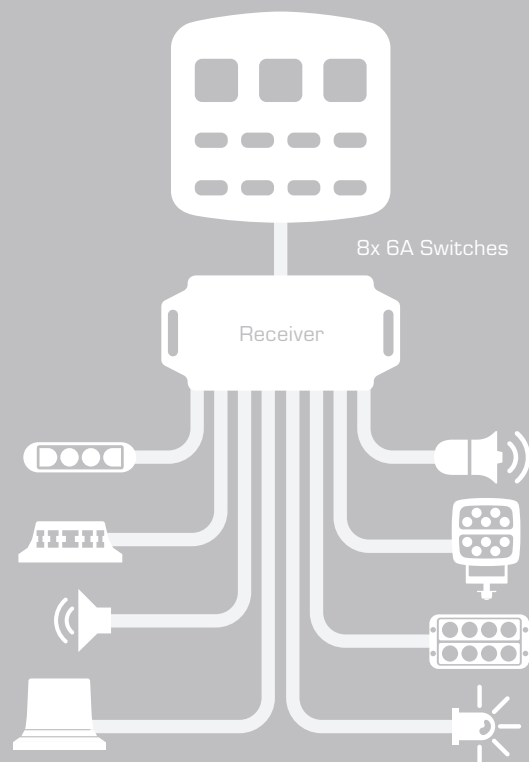

Master Switches

The ICS switch panel features 3 user configurable master switches. These switches can be used to link any combination of the 8 individual switches together to allow activation of multiple circuits via the switching of a single button. Note individual switches can be associated to more than one master switch.

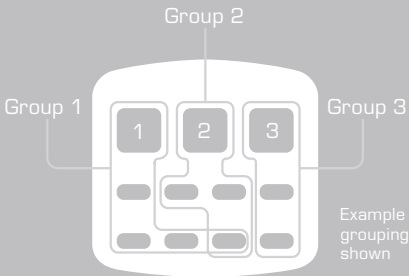

Custom assign any number of buttons to one of the three master switches



Watch video

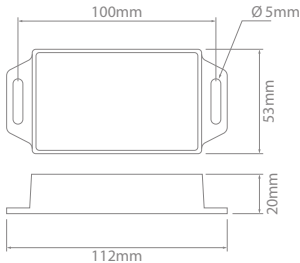
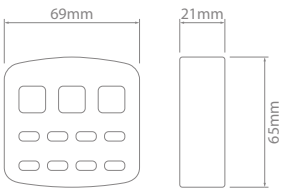

Receiver Module

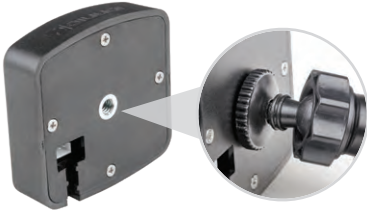

Mounting point on back of switch panel – use with common 1/4" thread adjustable mounts. Not supplied with mount.



ICS Switch Panel Kit

Part No.	Voltage	Kit Contents
ICS-01	12–24	1 x Switch Panel 1 x Receiver Module 1 x 4.5m Cable (Switch Panel to Receiver) 4 x Overlay Function Decals 1 x Mounting Screws & Washers 1 x Double-sided Mounting Tape



ICS-01S



50127



50128



HT-4301

ICS Switch Panel – Accessories & Related Products

Part No.	Description
ICS-01S	Slave Receiver Module
50127	AMP Superseal kit – 3 circuits – Receptacle. Includes contacts and seals
50128	AMP Superseal kit – 3 circuits – Plug. Includes contacts and seals
HT-4301	Parallel Crimping tool. Crimp Range – 0.35–0.5, 0.75, 1.0, 1.5mm ²





9V 32V IP67 Made in North America

- Easy calibration (1 to 9 point) suitable for all tanks of any size or shape.
- Programmable output, typically used for auto-fill function, low/high tank level warning etc.
- One wire data link allows for unlimited optional remote displays.
- Ultra bright LEDs easily viewable from 180° to 9 precise tank levels.
- Custom scrolling text sequences on power up.
- Built-in self diagnostics displayed through scrolling text.
- Optional remote driver module used to control external lights, sirens etc concurrent to ITL display.
- Uses proven industrial pressure transducer instead of probes.
- Multiple programmable features inbuilt, including LED dimming level and anti-slush function.
- Rocker switch sized Mini Remote Indicator available.
- Made in North America.

Voltage : 9-32V
Current Draw : 100mA @ 13.8V
Output : Digital 250mA ground
CAN : SAE J1939
Construction : Polycarbonate
Bezel : Die-cast Alloy
Ingress Protection : IP67
Operating Temperature : -40°C to 85°C

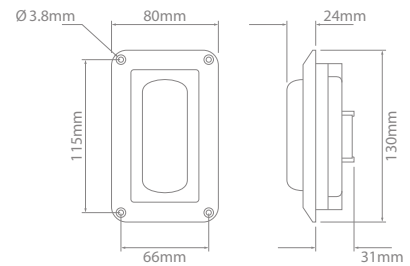

ITL-40 System Layout 1 – Simple Install

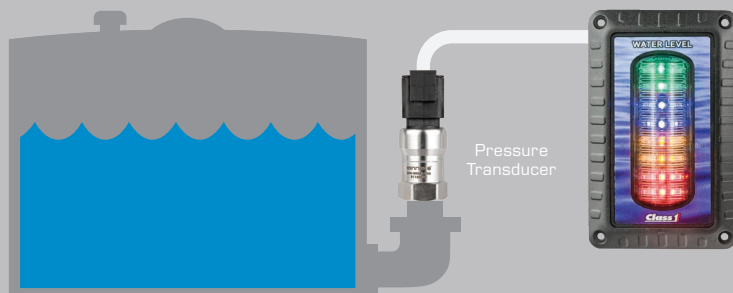

Illustration shows a typical tank monitoring system demonstrating the simplicity of installation and the use of the programmable output function.

Typically used for auto-fill function, low/high tank level warnings etc.





ITLF-40R

Intelli-Tank Level 40 – Kits

Decal Text	Decal Colour	LED Colour				
		Green	Blue	Yellow	Red	Multi
“WATER LEVEL”	Blue	ITL-40G	ITL-40B	ITL-40Y	ITL-40R	ITL-40M
“FOAM LEVEL”	Red	ITLF-40G	ITLF-40B	ITLF-40Y	ITLF-40R	ITLF-40M
“CLASS A FOAM LEVEL”	Yellow	—	—	—	—	ITLF-40MYA
“CLASS B FOAM LEVEL”	Yellow	—	—	—	—	ITLF-40MYB

- Kit contents:
- 1 x ITL-40 Indicator
 - 1 x Indicator Decal
 - 1 x Harness – 3m (118485-10-DTM)
 - 1 x Pressure Transducer (200-00093-001)
 - 1 x Foam Adaptor (102219 Foam Kits only)

Multi-colour indicators feature 2 rows of Green, Blue, Yellow and Red LEDs from top to bottom.

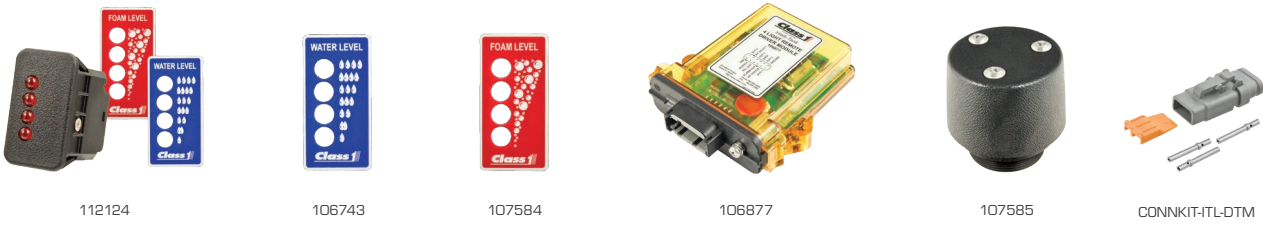

Intelli-Tank Level 40 – Accessories

Part No.	Description
112124*	Mini Remote Indicator – 12–24V
106743	Mini Remote Indicator Decal – Blue “WATER LEVEL”
107584	Mini Remote Indicator Decal – Red “FOAM LEVEL”
106877	Driver Module 4 x 7.5A outputs – 12–24V
107585	Zero Pressure Vacuum Vent MNPT2”
CONNKIT-ITL-DTM	Connection kit. Suits ITL-40 harness (118485-10-DTM)

* 112124 supplied with 1 x Water Decal & 1 x Foam Decal.



Displays / HMI



Fig 1

200-00093-001

102219

118485-10-DTM

Intelli-Tank Level 40 – Individual Components

Part No.	Description	Fig
123340-01	LED Indicator, no decal – Red	1
123340-03	LED Indicator, no decal – Yellow	1
123340-04	LED Indicator, no decal – Green	1
123340-05	LED Indicator, no decal – Blue	1
123340-06	LED Indicator, no decal – Multi-colour	1
117690	Indicator decal – “WATER LEVEL” – Green	
117691	Indicator decal – “WATER LEVEL” – Blue	
117700	Indicator decal – “WATER LEVEL” – Orange	
117692	Indicator decal – “FOAM LEVEL” – Red	
117693	Indicator decal – “FOAM LEVEL” – Green	
117694	Indicator decal – “FOAM LEVEL” – Yellow	
117695	Indicator decal – “FOAM LEVEL” – Blue	
117696	Indicator decal – “CLASS A FOAM LEVEL” – Yellow	
117697	Indicator decal – “CLASS B FOAM LEVEL” – Yellow	
117698	Indicator decal – “CLASS B FOAM LEVEL” – Green	
200-00093-001	Pressure transducer	
102219	Foam tank adaptor for pressure transducer	
118485-10-DTM	Harness – 3m	

Custom labels available upon request.

Other harness lengths available upon request.

ITL-40 System Layout 2 – With Options

Illustration shows a typical tank monitoring system incorporating the optional Mini Remote Indicator and Driver Module used to control external lights/alarms.

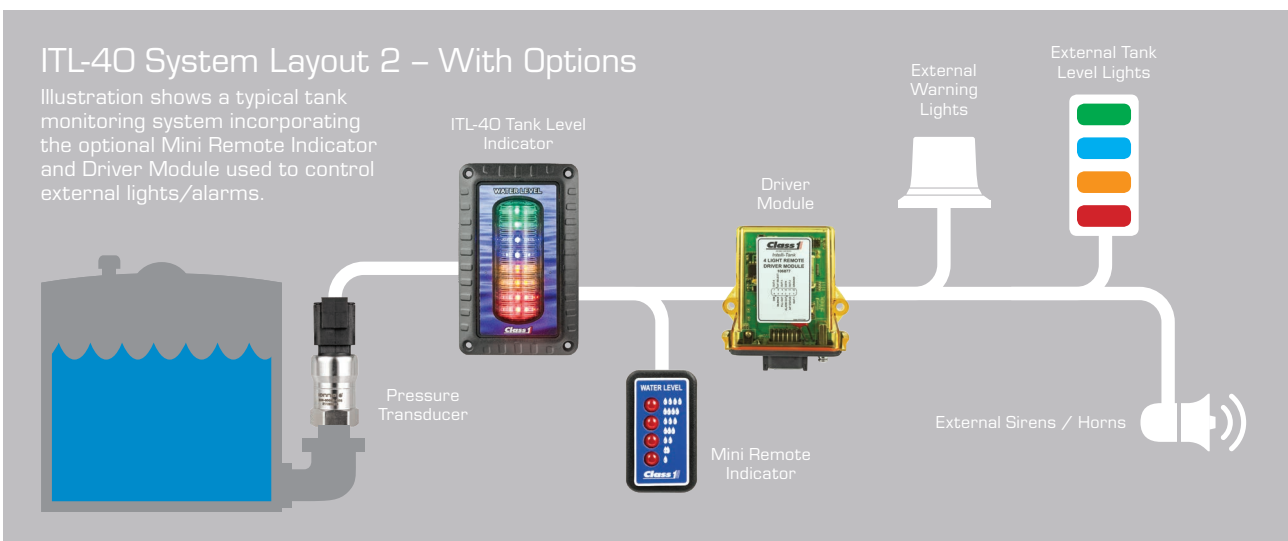

- Engine RPM display.
- System voltage display & alarm.
- Engine oil pressure display & alarm.
- Engine temperature display & alarm.
- SAE J1587 & SAE J1939 compliant models.
- Super bright displays for maximum visibility in daylight.
- Output for external alarm (0.25A), input for alarm silencing.
- Environmentally sealed – IP67.
- Multi-voltage.
- Made in North America.



Voltage :	9-32V
Current Draw :	185mA @ 13.8V
Max Alarm Draw :	250mA
CAN :	SAE J1939
Construction :	Polycarbonate
Bezel :	Aluminium Alloy
Ingress Protection :	IP67
Operating Temperature :	-40°C to 85°C

Made in North America 9V 32V IP67

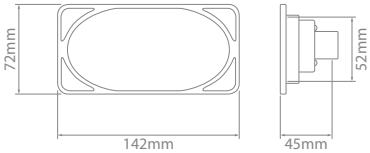

Engine Information Centre – IV

Part No.	Description
108661	Engine Information Centre IV



Engine Information Centre – Connection Kit

Part No.
CONNKIT-ENFOIV

Crimping tools can be found on page 96.



Emergency Services

App



Emergency Services Fire Appliances

For decades Class 1 systems have been the backbone of the fire appliance and allied emergency services vehicle industry.

Adoption of Class 1 multiplexing has simplified and reduced the hardware components required for the electrical system and have also increased the range of possibilities of what can be controlled.

- Pump governing
- Fluid level monitoring
- Fluid flow control
- Lighting operation
- Switch operation
- Safety interlocking
- P.T.O.
- Light mast
- Warning indication
- Interface with OEM chassis
- Emergency lighting
- Inbuilt diagnostics
- Low voltage management



LV800



Supernode II



Smart Touch



HD PDM



PDM



I/O Module



Sentry



Twister



ITL System

Displays / HMI

Seat Belt Warning System



9V 32V Made in North America

- Utilises SAE J1939 CAN standard to record NFPA required data.
- Large Seat Belt Warning System displays the status of up to 12 seats simultaneously.
- Display available in rocker size, can be integrated with Supernode.
- Can integrate with Vehicle Data Recorder for event archiving, see page 66.
- Input Module is environmentally sealed – IP67.
- Multi-voltage.
- Made in North America.

Voltage : 9-32V
 CAN : SAE J1939, 250 Kbit/second
 Construction : Polycarbonate
 Ingress Protection : Input Module IP67
 Operating Temperature : -40°C to 85°C

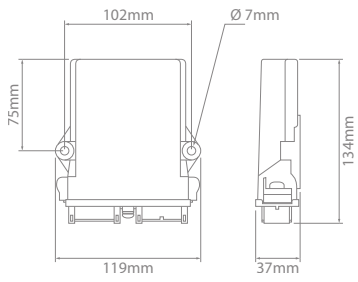

Seat Belt Warning System – Input Module

Part No. 118093 Current Draw (mA) @ 13.8V 57

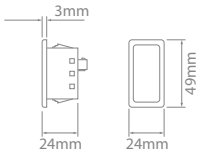
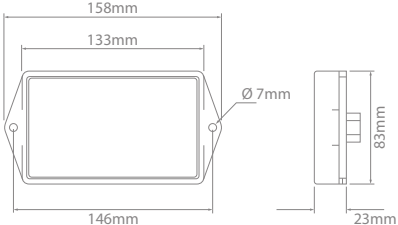

Indicates all occupied seats have seat belts engaged



Each occupied seat without a seat belt engaged is momentarily displayed until all are engaged



118620

Seat Belt Warning System – Displays

Part No.	Description	Current Draw (mA) @ 13.8V
118551	Large multi-seat belt display	75
118620	Small seat belt indicator	57

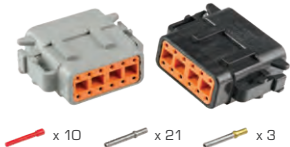

CONNKIT-ID

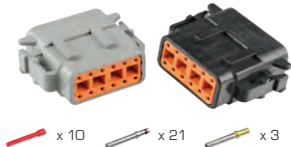

CONNKIT-ID-PB



CONNKIT-TWISTER

Seat Belt Warning System – Connection Kits

Part No.	Description	Suits
CONNKIT-ID	Connection Kit	Seat Belt Warning Input Module (118093)
CONNKIT-ID-PB	Connection Kit – Purple Band Socket	Seat Belt Warning Input Module (118093)
CONNKIT-TWISTER	Connection Kit	Large Seat Belt Display (118551)

Crimping tools can be found on page 96.





- Super bright, easy to see display.
- 90dB warning buzzer included in selected models.
- Compact design.
- Silence button for audible alarm included.
- Environmentally sealed – IP67.
- Multi-voltage.
- Made in North America.

9V / 32V IP67 Made in North America

Voltage : 9-32V
 Alarm Output Polarity : Negative
 Ingress Protection : IP67
 Operating Temperature : -40°C to 85°C

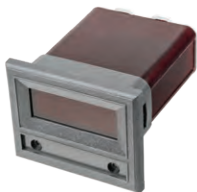
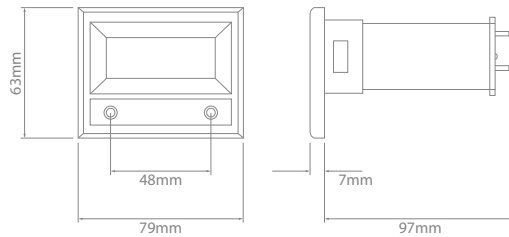

111667



103523



102161



102035



102008

Minder Series Kits – Pressure Gauge

Part No.	Description	Kit Contents
PSIS	Digital Pressure Gauge Kit	1 x Display (111667) 1 x Decal "PRESSURE" (103523) 1 x Transducer (102161) 1 x Harness – 3m (102035) 1 x Display Mounting Kit (102008)

The Pressure Gauge displays current pressure or vacuum [kPa, PSI or BAR] in a numeric format.

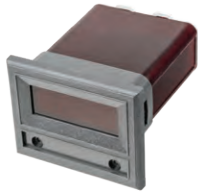

111663



103522



102714



102033



102008

Optional accessory
Flow Sensor mounting boss

SFM



Minder Series Kits – Flowminder

Part No.	Description	Kit Contents
FMS	Flowminder Kit	1 x Display (111663) 1 x Decal "FLOWMINDER" (103522) 1 x Flow Sensor (102714) 1 x Harness – 3.1m (102033) 1 x Display Mounting Kit (102008)
SFM	Flow Sensor mounting boss	

Displays current flow (litres per minute) in a numeric format.



111653



101995



102606



102088



100571



102671



102008

Minder Series Kits – Loadminder

Part No.	Description	Kit Contents
LMS	Loadminder Kit	1 x Display (111653) 1 x Decal "LOW LEVEL AERIAL LOADING" (101995) 1 x Pressure Transducer (102606) 1 x Silence Button (102088) 1 x Buzzer 90dB (100571) 1 x Harness – 3m (102671) 1 x Display Mounting Kit (102008)

Loadminders display the current low-level load in a simple, easy-to-read LED bar style display that instantly adjusts as the ladder angle, extension or live load changes.

As the loading increases, so does the number of bars that are illuminated on the display. When the maximum low-level loading approaches (as determined by the aerial manufacturer and calibrated at the factory) the display will begin to flash.

A slight (25-50kg) additional load will cause the audible alarm to sound which alerts the operator to an overload condition.

- Display flashes when approaching maximum load
- Audible alarm when maximum reached
- Auxiliary output activates strobe (optional)



Displays / HMI



Minder Series Kits – OxyMinder

Part No.	Description	Kit Contents
OMS	Oxygen Minder Kit	1 x Display (111654) 1 x Decal "% OXYGEN REMAINING" (101996) 1 x Pressure Transducer (102606) 1 x Silence Button (102088) 1 x Buzzer 90dB (100571) 1 x Harness – 3m (102671) 1 x Display Mounting Kit (102008)

OxyMinder displays current oxygen level in a simple, easy-to-read LED bar style display.

- Display flashes at 25% total air capacity
- Audible alarm sounds at 20% air capacity



Minder Series Kits – AirMinder

Part No.	Description	Kit Contents
AMS	Airminder Kit	1 x Display (111655) 1 x Decal "% AIR REMAINING" (101994) 1 x Pressure Transducer (102606) 1 x Silence Button (102088) 1 x Buzzer 90dB (100571) 1 x Harness – 3m (102671) 1 x Display Mounting Kit (102008)

Airminders display current breathing air level in a simple, easy-to-read LED bar style display.

- Display flashes at 25% total air capacity
- Audible alarm sounds at 20% air capacity
- Ideal for aerials, aerial platforms, air trucks and C.F.R. vehicles



Minder Series Kits – Spare Part

Part No.	Description	Suits
100944	Replacement display bezel	All Minder Series